

Similarity check _ IoT-Based Garbage Container System Using NodeMCU ESP32 Microcontroller

By Anthony Anggrawan

IoT-Based Garbage Container System Using NodeMCU ESP32 Microcontroller

Anthony Anggrawan⁵⁰, Sirojul Hadi, and Christofer Satria
Universitas Bumigora, Mataram, Indonesia
Email: {anthony.anggrawan, sirojuhadi, chris}@universitasbumigora.ac.id

Abstract—The way to increase the convenience of waste container users and monitor the level of waste container content can be by utilizing IoT technology and building an intelligent waste container system. Therefore, this study aims to conduct research and development (R&D) of an Internet of Things (IoT) control system to automatically open and close the lid of trash containers and detect the fullness of garbage in trash containers. This research method is a combination of experimental and survey methods. The research results show that the waste container control system effectively opens and closes the lid of the garbage container at a distance of about 40 cm between the distance ultrasonic sensor of garbage containers and users. In addition, the garbage janitor can monitor the level of garbage that is filled in the garbage container correctly through the website and telegram on his cell phone, and users of trash containers are more comfortable disposing of waste.

Index Terms—internet of things, garbage container, microcontroller, IoT-based, control system

I. INTRODUCTION

The garbage disposal container provides a special place for everyone to dispose of garbage. Providing a receptacle for garbage disposal can maintain the beauty and cleanliness of the environment because the waste is not scattered everywhere. However, garbage is a major problem in cities with piles of garbage in the open due to failure to manage waste containers [1]. Improper waste management creates health problems and environmental pollution [2]. That is why overcoming the waste problem is urgent and crucial at this time [3]. The provision of adequate waste containers is one way that can prevent scattered trash. Generally, waste containers have a lid that is useful for avoiding odors from coming out of the garbage. Unfortunately, most trash containers are still manual to open and close the cover of the trash container when the user wants to throw the trash into the trash container. Indeed, some other garbage containers already have pedals to open the lid of the garbage container by stepping on or pressing the pedal to open the cover of the garbage container when disposing of garbage, but it is still semi-manual. In other words, it is necessary to develop a trash

can lid that can automatically open the cover to increase the practicality and convenience of users throwing trash into the garbage container without pressing the pedal to disclose the trash can lid.

Besides that, as stated by previous researchers, the problem that arises in waste management is that no scheduling system can regulate cleaning workers to clean the trash when the trash in the container is full of garbage [4]. The janitor does not know when the trash can is full of waste [4]. Thus, it is also essential to know which bins are full of garbage so that the cleaners can immediately dispose of the waste at a garbage collection point (or incinerator or trash crusher, or trash recycling bin). In essence, emptying waste containers, especially those in public places such as stations, markets, and hospitals, needs to be done on time and disposed of at a garbage collection point. The timely transportation process is one way to help overcome the problem of garbage accumulation in garbage containers. Therefore, proper monitoring system mechanisms are necessary to support waste management [3]. Because, after all, the improper management of waste containers has a substantial negative impact on the environment and public health [5]. Waste management activities include the necessary actions so that the waste is transported to the landfill [6]. Garbage janitors generally transport wastes based on a predetermined schedule [2]. So that when the garbage container is full of trash, and at that time, it is not the time (not the plan) for the garbage janitor to clean the garbage, then everyone's garbage disposal is no longer thrown in the garbage container [2]. In other words, delay in emptying trash containers that are already full of garbage in public places can disrupt the comfort and order of the community in disposing of waste in the waste container. However, if the garbage container janitor still has to check which garbage containers are full of trash, this takes time to review and is inefficient. Moreover, according to Kumar et al. (2021), developing a more efficient waste management system is to build a control system [7]. So that is why previous researchers emphasized that creating an intelligent waste container system is essential for ecological well-being and is a clever solution to the waste management system [8].

Manuscript received August 17, 2021; revised December 6, 2021.

IoT technology is increasing rapidly in various fields for real-time and accurate monitoring [9][10]. IoT makes it possible to realize ubiquitous access [11], has been used in the embodiment of the management system [12], and supports heterogeneous models of automation [13]. In addition, the adoption of intelligent applications and IoT technology provides real-time information for cleaners to monitor waste containers [14][15].

The most effective method for preventing environmental problems in waste management is to utilize IoT technology and intelligent application systems [16]. In addition, the latest study recommends the realization of a smart waste management system for collecting waste in its place and timely disposal of waste in containers [17]. That is why it is not surprising that the researchers suggested the need for intelligent applications in waste management and IoT to overcome the waste problem [2]; therefore, the main objective of this research is to research and develop an IoT-based intelligent waste container using the microcontroller. The IoT-based clever waste container from the results of this study is beneficial in: The lid of the garbage container will automatically open and close when someone is going to throw out the trash; Provide a warning via telegram on the mobile phone of the waste cleaning worker when the garbage in the waste container is full of waste; Provide a real-time visual indicator of the level of fullness of the waste content in each waste container via the Web so that the cleaners know which garbage container will be full of garbage first, and Provide convenience for everyone in terms of disposing of waste by automatically opening and closing the waste container.

A microcontroller in the form of an IC chip (Integrated Circuit) has a role as a microcomputer to perform certain operations. The microcontroller consists of a processor or central processing unit (CPU), random access memory (RAM) and Read-Only Memory (ROM), and programmable Input and Output devices. Microcontrollers are generally used with sensors to monitor the environment and control something [18]. Microcontroller implementation covers control systems, wireless systems, medical, and automation systems [19]. The selection of the type of microcontroller used in developing or building a control system is one hundred percent tailored to the needs. It means that the passage of the type of microcontroller used in developing the control system must be appropriate to realize a control system that works reliably or as planned. This research uses the NodeMCU ESP32 microcontroller. The NodeMCU ESP32 microcontroller is helpful as a web server and for real-time work [20]. NodeMCU ESP32 is a system-on-chip combo microcontroller that requires low power and is inexpensive [21]. In addition, the NodeMCU ESP32 microcontroller facilitates Wi-Fi, large capacity flash memory, dual-mode Bluetooth, and other peripherals [18]. The microcontroller NodeMCU ESP32 is a development of the 8266 microcontroller version. The reliability of the NodeMCU ESP32 is that it has the best Radio Frequency (RF) power and performance and is useful in power scenarios [22]. The

use of the ESP-32 microcontroller has been widely in the development of low-cost IoT systems [21][23][24][25].

TABLE I. COMPARISON OF SEVERAL MICROCONTROLLERS

Type	Support Wi-Fi	Support Bluetooth	Bus Size	Price
NodeMCU ESP32	Yes	Yes	32-bit	\$13
Raspberry Pi	Yes	Yes	32-bit	\$150
AVR	No*	No*	8-bit	\$23
ARM	No*	No*	32-bit	\$77
MCS-51	No*	No*	8-bit	\$23
PIC	No*	No*	8-bit	\$29

* Need an additional network

The rest of this paper's writing organization is as follows: The second subsection discusses Related Works. The third subsection describes the Research Methodology. The fourth sub-section explains the implementation of the research results and then ends with a conclusion sub-section that explains the findings obtained, including suggestions for further research.

II. RELATED WORKS

The following is a brief literature review of several scientific works related to this research article. Ryan T O'Connor, Dorothea C Lerman, and Jennifer N Fritz (2010) examined the effect of the location of the trash container on the attitude of students, staff, and guests in disposing of waste in public universities [26]. Previous research did not build a system to open and close the garbage container automatically and did not detect the level of waste in the garbage container. In contrast to the research in this article, building a control system to control the opening and closing of the garbage automatically opens when someone is about to take out the trash and closes the lid when someone finishes taking out the trash. In addition, the research in this article is based on IoT; when the garbage container is full of waste, the garbage container's sensor will inform the control system via the internet that the garbage container is full. Arsa Priyo Rahardjo, Suraidi, and Hadian Satria Utama (2017) developed a sensor to automatically open the garbage container's lid and provide a light indicator when the trash container is full of waste [27]. This previous research has similarities with the research in this article on developing waste container controllers. The difference is that previous studies did not build a remote control to ensure the bin is full of waste. In contrast, the article in this study has a remote control or IoT-based to detect that the garbage container is full. In other words, the advantage of the research in this article is that the janitor does not need to check to location whether the trash container is full or not. Instead, the janitor will receive a notification when the trash container is full-on his cell phone. Fady E. F. Samann (2017) built a smart waste container that can give a warning when the trash can is full of garbage [28]. In contrast, the study of this article provided a warning notification of the fullness level of the waste container via telegram and website. Furthermore, the previous research did not conduct a trial implementing smart waste containers built for users of garbage containers and the effect of garbage containers made for garbage container cleaners. In contrast, this research article pilots the implementation of intelligent

waste containers built to assess the level of comfort and changes in user compliance in disposing of waste in smart waste containers and the effect of clever waste containers on garbage container cleaners. In addition, the study in this article also has automation to open the lid of the garbage container when someone is going to throw out the garbage, which was not in the previous research.

Sandeep M. Chaware (2017) offered an IoT-based system to monitor the fullness of trash cans and inform the time for garbage collection vehicles to collect garbage [29]. This previous research developed a system design project to collect waste on time. In contrast, the research in this article informs when garbage collection is carried out and focuses on developing smart garbage containers that can automatically open and close garbage containers. In addition, the research in this article has a different research method from the previous study. Theodoros Anagnostopoulos et al. (2017) presented the strengths and weaknesses of various ICT-based waste management models [30]. This last study conducted a survey (review) of various earlier studies so that the research method was a literature study method. In contrast to the research in this article, it was conducting experimental research to build IoT-based smart waste containers and conducting field trials of intelligent waste containers developed on waste container users and garbage container cleaners to see the effect through surveys. Kellow Pardini et al. (2018) reviewed the possibilities of automation of waste

management using IoT technology [15]. This previous research and the research in this article both paid attention to the problem of waste management. However, the difference is: that the previous research only surveyed research to solve the problem of waste management; meanwhile, the research in this article combines experimental and survey methods to research and develop IoT-based smart waste containers. In other words, previous research did not build an intelligent waste container control system as research in this article. Still, it only analyzed the possibility of using IoT technology to automate waste management. Behzad Esmailian et al. (2018) showed some examples of electronic waste control efforts to offer the suitability of implementing sensor-based intelligent waste management systems [14]. However, the previous research is a literature study, while the research in this article is experimental and survey research.

In the meantime, Pujari Y. M. and Patil S. S. (2018) suggested that methodologies and systems monitor trash containers and warn departments regarding the actions to waste in the trash [31]. However, the main focus of previous research was to introduce environmental hygiene with easy-to-realize waste management and monitoring system. Meanwhile, the article in this study focuses on building intelligent application systems and hardware controllers for IoT-based waste container management.

TABLE II. COMPARISON OF THIS ARTICLE'S WORK WITH PREVIOUS RELATED WORKS

Research by	Research method	Build Control System			Microcontroller type	Build Apps	Field trial trash system	Description
		IoT	Trash					
			Lid	Bin				
Ryan T O'Connor et al. (2010) [26]	Observation	No	No	No	None	No	No	It does not build an automatic system for opening and closing the garbage container lid and also does not detect the fill level in the garbage container
Arsa Priyo Rahardjo et al. (2017)[27]	Experiment	No	Yes	Yes	AVR (Arduino Uno R3 /ATMega328P)	Yes	No	Automatically opens the lid of the container and gives a light indicator when the bin is full and not IoT based
Fady E. F. Samann (2017) [28]	Experiment	No	No	Yes	AVR (Arduino Nano R3 / ATmega328)	Yes	No	This article built a smart waste container that can give a warning when the trash can is full of garbage
Sandeep M. Chaware et al. (2017) [29]	System design	Yes	No	Yes	AVR (Arduino ESP 8266)	No	No	Propose a system to detect time for IoT based garbage collection.
Theodoros Anagnostopoulos et al. (2017) [30]	Survey	No	No	No	None	No	No	A literature study to describe the strengths and weaknesses of various ICT-based waste management models
Kellow Pardini et al. (2018) [15]	Survey	No	No	No	None	No	No	This article reviewed the possibilities of automation of waste management using IoT technology
Behzad Esmailian et al. (2018) [14]	Review	No	No	No	None	No	No	This article focuses on a literature review to address environmental problems and waste management..
Pujari Y. M. and Patil S. S. (2018) [31]	System design	No	No	No	None	No	No	This article suggests a waste container monitoring methodology and system
Teoh Ji Sheng et al. (2020) [32]	Experiment	Yes	No	Yes	AVR (Arduino Uno)	No	No	This article realized a waste management system with LoRa communication protocol based on TensorFlow model.
Xiangru Chen (2022) [33]	Simulation	Yes	No	Yes	None	Yes	No	This article proposed a machine learning system that can classify IoT-based recycling waste to solve the waste problem in smart cities.
Our research	Experiment and Survey	Yes	Yes	Yes	NodeMCU ESP32	Yes	Yes	Our research builds an intelligent system to automatically open and close waste bin lids and control IoT-based waste container content levels. The hardware and applications used are designs constructed by researchers. Researchers also conducted field trials on the developed intelligent waste container system.

Teoh Ji Sheng et al. (2020) offered an embodiment of a waste management system. However, this previous study used the LoRa communication protocol and TensorFlow object detection in building a waste management system [32]. Meanwhile, in contrast to the research in this article, the NodeMCU ESP32 controller and ultrasonic sensor devices and the PHP and C programming languages are used in building a waste container management system. Another difference between this article and the previous research is that the article in this study conducted a trial on smart waste containers built that did not exist in the prior research.

Xiangru Chen offered a machine learning system to classify recyclable waste by suggesting IoT-based solutions in smart cities to solve the waste problem [33]. Previous research focused on developing machine learning algorithms for classifying and separating waste for recycling purposes, in contrast to the research in this article, building an intelligent system to automatically control the opening and closing of the garbage container by using a microcontroller. In addition, the research in this article is experimental, while the previous research is a simulation of machine learning programs for the classification and separation of waste.

IoT is a future communication technology equipped with microcontrollers and other communication protocols [34]. In essence, various supporting devices accompany the IoT era, such as Arduino controller devices for monitoring and controlling other equipment [30]. IoT supports the realization of intelligent application systems in multiple fields, including health, education, transportation, and the environment [35][36][37]. Besides that, the power of IoT is that it allows the merging of various technologies to create dynamic and efficient models [38], including collaboration with intelligent waste management applications. So it is no longer a secret nowadays; smart applications and IoT have become very dominant solutions to address the needs of managing environmental problems, such as controlling the waste problem [39]. One of the environmental problems in most cities today is related to the problem of waste collection and waste disposal [28]. Therefore, the waste management system needs to be replaced with an intelligent system [40] and an IoT-based controller.

Developing intelligent application systems and IoT is essential to overcome the garbage problem [41]. Maybe that is why previous researchers suggested conducting further research on waste disposal containers and landfills (O'connor, Lerman, & Fritz, 2010). Because in essence, sensor implementation on trash bins in collaboration with IoT technology allows real-time control and provides efficient results [42]. Although, previous research confirms that failures occurred in controlling the waste disposal containers available at various locations (O'connor et al., 2010). Therefore, researching and developing a control system for the

waste disposal containers available at multiple locations is vital, and this research provides a solution to realize.

A review of several related works shows that this research is different from previous studies (as shown in Table 2); especially in terms of the method used is a combination of experimental and survey procedures. Likewise, this study conducted a field trial on developed smart waste containers that were not in previous studies. Another novelty of this research is the application program, electronic circuits, and other supporting devices built according to the needs of this research. The application program built in this study uses the PHP and C programming languages.

III. METHODOLOGY

This research is a combination of experimental and survey methods. The garbage container control system in this research had an intelligent application that was built using the programming languages so that the garbage container cleaning officer, via his cellphone or personal computer, can track (know) which garbage containers are full of garbage. There are various computer programming languages [43], each of which has advantages in developing the desired application program [44][45]. This study uses the PHP and C programming languages to create intelligent application programs. The PHP programming language plays a role in realizing Web-based application programs [46]. Meanwhile, the C programming language plays a role in programming the NodeMCU ESP32 with Arduino software IDE to function as a controller for other hardware work, such as sensors and servo motors.

The NodeMCU ESP32 microcontroller controls ultrasonic sensors, servo motors, and Wi-Fi to open or close the trash can and detect the level of garbage filling the trash can. NodeMCU ESP32 is an Integrated Circuit (IC) chip equipped with Wi-Fi and Bluetooth functions. This study uses the survey method to collect quantitative data in the form of ordinal data. The number of survey sample data was 100 respondents who were randomly selected from the existing population. The survey was conducted to test the level of comfort and changes in the obedience of users (garbage disposal actors) in disposing of waste in the intelligent waste container built in this study.

IV. RESULT AND DISCUSSION

The embodiment of an IoT-based garbage container system Using NodeMCU ESP32 microcontroller includes preparation, implementation, and testing stages. In the preparatory phase, the main thing is determining the hardware and software that meet the desired requirements or specifications. Then, the main thing to do at the implementation stage is to design block diagrams and electronic circuits of hardware. While at the trial phase is testing the work of the developed control system.

TABLE III. HARDWARE REQUIREMENT







Device	Amount	Specification	Function	Hardware Image
US-100 Ultrasonic Sensor	2	47 t voltage: 5V DC; Induction angle: not more than 15 degrees; Detection distance: 2cm to 450cm	The first ultrasonic sensor detects the presence of objects in front of the garbage container. In contrast, a second ultrasonic sensor detects the level of waste in the bin.	
Austarhobby - Ax8601 Digital Servo	1	53 Operating voltage range: 4.8 to 6.0V; Operating speed (6.0V): 0.15 sec / 60 degree; Angle: 130 to 160; Stall torque (6.0V): 25kg/cm	This device is as a driver to open and close the lid of the garbage container.	
ISD1820 voice recorder (and sound playback) module	2	On-chip 8Ω Speaker driver; Record up to 20 seconds of audio; Operating voltage range: 3.3 to 5V	The first ISD1820 is used for sound notification when the open trash can lid. Meanwhile, the second ISD1820 is used for sound notifications every 3 minutes to remind everyone to throw garbage in the trash container.	
NodeMCU ESP32	1	35 Dual-core 32-bit processor with built-in 2.4 GHz Wi-Fi and Bluetooth; RAM: 520KByte; Operating voltage range: 2.2 to 3.6V; USB micro	This device is a controller of electronic circuits or hardware to perform particular functions according to the application program developed.	
Speaker	2	8 ohm, 0.5 Watt	The speaker function is the voice output media of the notification sound issued by the ISD1820 device.	
Power Bank	1	Power bank output 3A, 5V.	A power bank is a power source for devices used for garbage containers.	
Garbage container	1	Height 36 cm, diameter 19 cm, plastic material	As a prototype waste container for research and development trials of IoT-Based smart waste containers	

TABLE IV. SOFTWARE REQUIREMENTS

59 Software	Function
Arduino IDE Software	Arduino IDE (Integrated Development Environment) functions as a media editor for program writing, compilation, and uploading of intelligent application programs built in this research to the microcontroller board.
PHP and C++ Coding programs	The designed coding program has a function so that the designed hardware can work as designed, namely an intelligent system for controlling waste containers to open and close garbage containers automatically and send to telegram the level of fullness of the waste container contents.
Telegram	Its function is an instant messaging application that users can use to receive messages.

A. Required hardware and software

Tables 3 and 4 show some of the devices (hardware and software) needed to realize the control system in this study.

B. Hardware and Design

The hardware realization is done by building a hardware block diagram and designing the hardware circuit board schematic according to the workflow of the desired waste container control system. The Block diagram and schematic of the hardware circuit board of this research are shown in Figures 1 and 2.

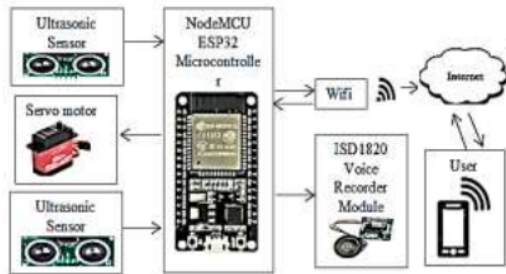

Figure 1. Electronic hardware block diagram

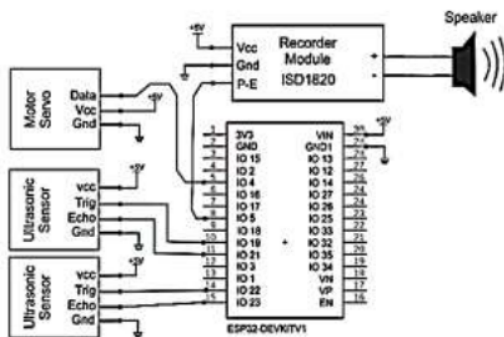
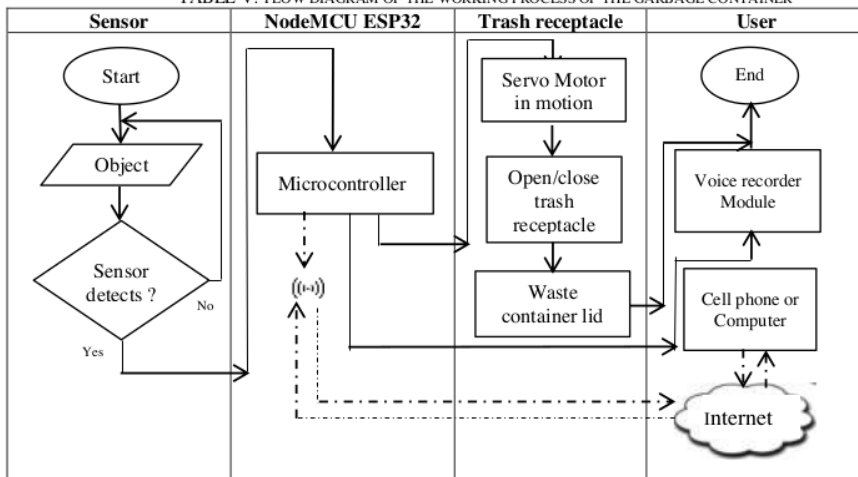

Figure 2. Hardware circuit board schematic

The workings of the system hardware are as follows: The cellular phone of the garbage container janitor, via the internet network, obtains information from the waste container application system, which has been programmed in the NodeMCU ESP32 microcontroller when the garbage container is filled with garbage. The garbage container is mechanically and electronically connected to a microcontroller engine, servo motor, and ultrasonic sensor. The ultrasonic sensor detects an object (everyone who will throw garbage). It sends the results of the object detection to the NodeMCU ESP32 controller. Then the controller sends instructions to the servo motor (moving the servo motor) to open the trash container and issue a sound notification via ISD1820

Table 5 shows the flow diagram of the working process of the garbage container. When there are objects or people who approach the garbage container, the ultrasonic sensor in the garbage container will detect the object. With the thing detected by the sensor, the microcontroller will move the motor, and the motor movement will open the garbage cover. The trash cover will close five seconds later after the object is no longer detected. When someone throws trash, a notification appears in the form of a thank-you voice for throwing trash in the trash container. Then the microcontroller connected to the internet using Wi-Fi will send the percentage level of the waste content (via telegram) in the garbage container and send the status of the contents of the garbage in the trash container in the form of a bar graph (via the website). In addition, at every specific periodic interval, the program on the microcontroller will send instructions to the voice recorder module to provide a sound notification of the recommendation to dispose of garbage in the garbage container.

TABLE V. FLOW DIAGRAM OF THE WORKING PROCESS OF THE GARBAGE CONTAINER



C. Waste Container Performance Test and Field Trial

Figure 3 shows a front view of a prototype intelligent waste container. The ultrasonic sensor installed on the front side of the top of the garbage container serves to detect the presence or absence of human objects in front of the garbage container. Likewise, on the inside of the waste container cover, an ultrasonic sensor is mounted on the center side of the container lid to detect the waste content level in the garbage container. For example, if the level of waste in the trash container is below 5%, a notification of the trash bin condition is still less than 5% filled. Meanwhile, if the trash content level in the trash container is above 90%, there will be a tone notification and a message that the trash container is full.



Figure 3. Prototype smart waste container built-in research

The test results of the built automatic garbage container control system show that the ultrasonic sensor installed in the garbage container successfully detects a human object at a distance of 40 cm from the sensor distance of the garbage container. The servo motor automatically works well to open the lid of the garbage container when the sensor has detected a human object near the garbage container. The garbage container cover will remain open as long as the human thing is still within the detection distance of the garbage container sensor. Cell phones and computers have succeeded in monitoring the percentage level of waste content in garbage containers via telegram. Likewise, through a cellular phone or computer, it is possible to monitor the status of waste containers in the form of a bar graph via a website. Garbage bins also work by design in emitting a sound at intervals of every five minutes to prompt everyone to throw trash in the trash can.

The field trial of the IoT-based intelligent waste system at a private university (for one month) in Indonesia shows that most students are more comfortable disposing of waste in smart waste containers. Besides, most of the students became more obedient in throwing garbage into smart garbage containers (see Figure 4 and Figure 5). The student's convenience in disposing of waste in garbage containers with lids that have to be opened manually is only 14%. However, by replacing the garbage containers with garbage container covers that can open and close the garbage container automatically, the convenience of students in disposing of garbage in the trash can on-site

waste increased to 100% (see figure 4).

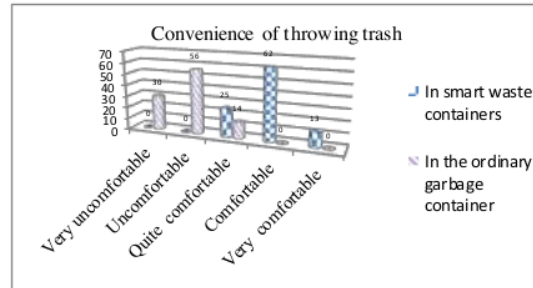

Figure 4. Student Perceptions regarding the Comfort Level of Disposing of Garbage in Smart Waste Containers

Student compliance in disposing of garbage in garbage containers with lids for garbage containers that must be opened manually is only 31%, but after the garbage containers are replaced with garbage container covers that can open and close the garbage container automatically, student compliance in disposing of garbage in garbage containers increases to 56.5% (see figure 5). In addition, the trial of applying an intelligent automatic waste control system in opening and closing the garbage lid satisfied a garbage container cleaning worker. As a result, the garbage container cleaning workers no longer need to continuously control the fullness of the garbage containers at the trash location but can monitor the percentage level of waste content in garbage containers via telegram.

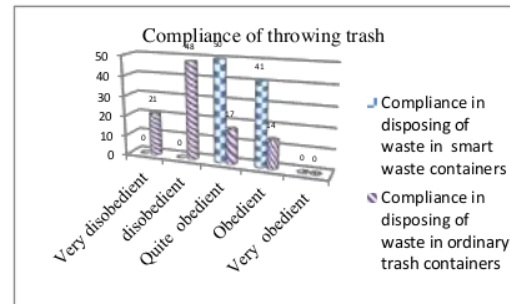

Figure 5. Students' Perceptions of Changes in Compliance Level for Disposing of Garbage in Smart Waste Containers

V. CONCLUSION

This research concludes that NodeMCU ESP32 Microcontroller helps realize IoT-based automated intelligent waste control system. The intelligent automatic garbage control system in opening and closing the garbage lid makes it more convenient for many parties. Furthermore, it improves compliance with disposing of waste in the garbage container. Again, the IoT-based waste container control system can help waste disposal workers determine the level of waste content in trash containers below 5% and above 90%. In other words, garbage cleaning workers can immediately clean up trash containers already full of garbage.

This study researches what previous researchers have never done to develop an intelligent garbage container

system by combining experimental and survey methods based on IoT using the NodeMCU ESP32 microcontroller. The novelty of the research in this article in conducting trials in the use of intelligent waste containers reveals a significant increase in user comfort and compliance in disposing of waste in waste containers. The smart garbage container trial results also show job satisfaction for garbage container cleaning workers. However, garbage container cleaning workers no longer need to check whether the garbage is full of waste but can be monitored via cellphone which trash containers need to be cleaned.

This study has shortcomings in terms of not being able to distinguish and no notification of different messages on organic and inorganic waste; therefore, further study needs to be developed to correct the shortcomings of the results of this study. Besides that, the waste container that is the model in this research is only a prototype without paying attention to the size of the garbage container, the harmonious appearance, production costs, and hardware durability, which should be a concern in further research.

REFERENCES

[1] H. N. Saha *et al.*, "Waste management using Internet of Things (IoT)," *2017 8th Industrial Automation and Electromechanical Engineering Conference, IEMECON 2017*, no. March 248, pp. 359–363, 2017.

[2] R. Khan *et al.*, "Machine Learning and IoT-Based Waste Management Model," *Comput. Intell. Neurosci.*, vol. 2021, pp. 1–11, 2021.

[3] P. K. S. Kumari, L. Jeewananda, R. Supunya, and V. Karunanayake, "IoT Based Smart Waste Bin Model To Optimize the Waste," *Univ. Moratuwa*, no. January 2018, pp. 359–363, 2019.

[4] J. M. Fernández-González, C. Díaz-López, J. Martín-Pascual, and M. Zamorano, "Recycling organic fraction of municipal solid waste: Systematic literature review and bibliometric analysis of research trends," *Sustain.*, vol. 12, no. 11, pp. 1–15, 2020.

[5] A. U. Gondal *et al.*, "Real time multipurpose smart waste classification model for efficient recycling in smart cities using multilayer convolutional neural network and perceptron," *Sensors*, vol. 21, no. 14, pp. 1–15, 2021.

[6] E. M. Abou-Nassar, A. M. Ilyyasu, P. M. El-Kafrawy, O. Y. Song, A. K. Bashir, and A. A. El-Latif, "DITrust Chain: Towards Blockchain-Based Trust Models for Sustainable Healthcare IoT Systems," *IEEE Access*, vol. 8, pp. 111223–111238, 2020.

[7] S. Kumar, D. Yadav, H. Gupta, O. P. Verma, I. A. Ansari, and C. W. Ahn, "A novel yolov3 algorithm-based deep learning approach for waste segregation: Towards smart waste management," *Electronics*, vol. 10, no. 1, pp. 1–20, 2021.

[8] A. Chauhan, S. Kumar, and C. Chauhan, "The interplay of circular economy with industry 4.0 enabled smart city drivers of healthcare waste disposal," *J. Clean. Prod.*, vol. 279, pp. 1–9, 2021.

[9] S. Malik, V. Dedeoglu, S. S. Kanhere, and R. Jurdak, "TrustChain: Trust management in blockchain and iot supported supply chains," in *Proceedings - 2019 2nd IEEE International Conference on Blockchain, Blockchain 2019*, no. July, pp. 184–193, 2019.

[10] W. Powell, M. Foth, S. Cao, and V. Natanelov, "Garbage in garbage out: The precarious link between IoT and blockchain in food supply chains," *J. Ind. Inf. Integr.*, vol. 25, no. 30, 2022.

[11] P. M. Kumar *et al.*, "Clouds Proportionate Medical Data Stream Analytics for Internet of Things-Based Healthcare Systems," *IEEE J. Biomed. Heal. Informatics*, vol. 26, no. 3, pp. 973–982, 2022.

[12] Q. Gao, S. Guo, X. Liu, G. Manogaran, N. Chilamkurti, and S. Kadry, "Simulation analysis of supply chain risk management system based on IoT information platform," *Enf. p. Inf. Syst.*, vol. 14, no. 9–10, pp. 1354–1378, 2020.

[13] S. Li, B. Zhang, P. Fei, P. M. Shakeel, and R. D. J. Samuel, "Computational efficient wearable sensor network health monitoring system for sports athletics using IoT," *Aggress. Polent Behav.*, p. 101541, 2020.

[14] B. Esmailian, B. Wang, K. Lewis, F. Duarte, C. Ratti, and S. Behdad, "The future of waste management in smart and sustainable cities: A review and concept paper," *Waste Manag.*, vol. 81, pp. 177–195, 2018.

[15] K. Pardini, J. J. P. C. Rodrigues, S. A. Kozlov, N. Kumar, and V. Furta, "IoT-based solid waste management solutions: A survey," *J. Sens. Actuator Networks*, vol. 8, no. 1, pp. 1–25, 2019.

[16] T. Anh Khoa *et al.*, "Waste Management System Using IoT-Based Machine Learning in University," *Wirel. Commun. Mob. Comput.*, vol. 2020, 2020.

[17] S. O. Ajayi, L. O. Oyedele, M. Bilal, O. O. Akinade, H. A. Alaka, and H. A. Owolabi, "Critical management practices influencing on-site waste minimization in construction projects," *Waste Manag.*, vol. 59, pp. 330–339, 2017.

[18] M. Babiuch, P. Folynek, and P. Smutny, "Using the ESP32 microcontroller for data processing," in *Proceedings of the 2019 20th International Pathian Control Conference, ICCCP 2019*, 2019, no. May 2019.

[19] W. A. Salah and B. A. Zneid, "Evolution of microcontroller-based remote monitoring system applications," *Int. J. Electr. Comput. Eng.*, vol. 9, no. 4, pp. 2354–2364, 2020.

[20] I. Allafi and T. Iqbal, "Design and implementation of a low cost web server using ESP32 for real-time photovoltaic system monitoring," in *2017 IEEE Electrical Power and Energy Conference, EPEC 2017*, 2018, vol. 2017-October, pp. 1–12.

[21] G. Fabregat, J. A. Belloch, J. M. Badia, and M. Cobos, "Design and Implementation of Acoustic Source Localization on a Low-Cost IoT Edge Platform," *IEEE Trans. Circuits Syst. II Express Briefs*, vol. 67, no. 12, pp. 3547–3551, 2020.

[22] M. Fezari and N. Zakaria, "Comparative study between two Powerful NodeMCU Circuits: ESP32 and Comparative study between two Powerful NodeMCU Modules: ESP32 and ESP8266," *WSN Appl.*, no. April, pp. 1–9, 2019.

[23] A. G. Da Silva, L. M. G. Gonçalves, G. A. De Paula Caurin, G. T. B. Tamanaka, A. C. Hernandez, and R. V. Aroca, "BIPES: Block based integrated platform for embedded systems," *IEEE Access*, vol. 8, pp. 197955–197968, 2020.

[24] A. W. N. da Silva, L. D. S. Bezerra, S. C. S. Jucá, R. I. S. Pereira, and C. M. S. Medeiros, "Control and monitoring of a flyback DC-DC converter for photovoltaic applications using embedded IoT system," *IEEE Lat. Am. Trans.*, vol. 18, no. 11, pp. 1892–1899, 2020.

[25] M. Tueche, Y. Mohamadou, A. Djeukam, L. C. N. Kouekeu, R. Seujip, and M. Tonka, "Embedded Algorithm for QRS Detection Based on Signal Shape," *IEEE Trans. Instrum. Meas.*, vol. 70, 2021.

[26] R. O'connor, D. Lerman, and J. Fritz, "Effects of Number and Location of Bins On Plastic Recycling at a University," *J. Behav. Anal.*, vol. 43, no. 4, pp. 711–715, 2010.

[27] Arsa Priyo Rahardjo, Suraidi, and Hadian Satria Utama, "Perancangan Tempa Sampah Pembuka Tutup Otomatis dan Indikator Kapasitas," *Tesla*, vol. 19, no. 2, pp. 133–145, 2017.

[28] F. E. F. Samann, "The Design and Implementation of Smart Trash Bin," *Acad. J. Nawroz Univ.*, vol. 6, no. 3, pp. 141–148, 2017.

- [29] P. D. S. M. Chaware, S. Dighe, A. Joshi, N. Bajare, and R. Korke, "Smart Garbage Monitoring System using Internet of Things (IOT)," *Int. J. Innov. Res. Electr. Electron. Instrum. Control Eng.*, vol. 5, no. 1, pp. 74–77, 2017.
- [30] T. Anagnostopoulos *et al.*, "Challenges and Opportunities of Waste Management in IoT-Enabled Smart Cities: A Survey," *IEEE Trans. Sustain. Comput.*, vol. 2, no. 3, pp. 275–289, 2017.
- [31] Y. . Pujari and S. . Patil, "Smart Garbage Monitoring System," *Int. J. Integr. Educ.*, vol. 1, no. 1, pp. 71–76, 2018.
- [32] T. J. Sheng *et al.*, "An Internet of Things Based Smart Waste Management System Using LoRa and Tensorflow Deep Learning Model," *IEEE Access*, vol. 8, pp. 148793–148811, 2020.
- [33] X. Chen, "Machine learning approach for a circular economy with waste recycling in smart cities," *Energy Reports*, vol. 8, pp. 3127–3140, 2022.
- [34] L. Atzori, A. Iera, and G. Morabito, "The Internet of Things: A survey," *Comput. Networks*, vol. 54, no. 15, pp. 2787–2795, 2010.
- [35] L. Sumi and V. Ranga, "Sensor enabled Internet of Things for smart cities," in *2016 4th International Conference on Parallel, Distributed and Grid Computing, PDGC 2016*, 2016, pp. 29–37.
- [36] H. Arasteh *et al.*, "IoT-based smart cities: A survey," in *EEEIC 2016 - International Conference on Environment Electrical Engineering*, 2016, no. June.
- [37] T. Raaijen and M. Daneva, "Depicting the smarter cities of the future: A systematic literature review & field study," in *2017 Smart Cities Symposium Prague, SCSP 2017 - IEEE Proceedings*, 2017, pp. 46–50.
- [38] Z. Ou and X. Xie, "Research on vehicle bus network based on internet of things," in *Proceedings - 4th International Conference on Computational and Information Sciences, ICCIS 2012*, 2012, pp. 981–984.
- [39] F. Mattern, "From smart devices to smart everyday objects," *Proc. Smart Objects Conf.*, no. April, pp. 15–16, 2003.
- [40] M. O. Saeed, M. N. Hassan, and M. A. Mujeebu, "Assessment of municipal solid waste generation and recyclable materials potential in Kuala Lumpur, Malaysia," *Waste Manag.*, vol. 29, no. 7, pp. 2209–2213, 2009.
- [41] A. Zanella, N. Bui, A. Castellani, L. Vangelista, and M. Zorzi, "Internet of things for smart cities," *IEEE Internet Things J.*, vol. 1, no. 1, pp. 17–32, 2014.
- [42] H. Yuan, L. Shen, and J. Wang, "Major obstacles to improving the performance of waste management in China's construction industry," *Facilities*, vol. 29, no. 5, pp. 224–232, 2011.
- [43] A. Anggrawan, C. Satria, Mayadi, and N. G. A. Dasriani, "Reciprocity Effect between Cognitive Style and Mixed Learning Medium on Computer Programming Skill," *J. Comput. Sci.*, vol. 17, no. 9, pp. 814–824, 2021.
- [44] A. Anggrawan, C. K. Nuraini, Mayadi, and C. Satria, "Interplay between Cognitive Styles and Gender of Two Hybrid Learning to Learning Achievements," *J. Theor. Appl. Inf. Technol.*, vol. 99, no. 10, pp. 2404–2413, 2021.
- [45] A. Anggrawan, Mayadi, C. Satria, and L. G. R. Putra, "Scholarship Recipients Recommendation System Using AHP and Moora Methods," *Int. J. Intell. Eng. Syst.*, vol. 15, no. 2, pp. 260–275, 2022.
- [46] A. Anggrawan, C. Satria, C. K. Nuraini, Lusiana, N. G. A. Dasriani, and Mayadi, "Machine Learning for Diagnosing Drug Users and Types of Drugs Used," *Int. J. Adv. Comput. Sci. Appl.*, vol. 12, no. 11, pp. 111–118, 2021.

Similarity check _ IoT-Based Garbage Container System Using NodeMCU ESP32 Microcontroller

ORIGINALITY REPORT

24%

SIMILARITY INDEX

PRIMARY SOURCES

- | | | |
|---|---|----------------|
| 1 | downloads.hindawi.com
Internet | 124 words — 2% |
| 2 | thesai.org
Internet | 87 words — 1% |
| 3 | www.ijrte.org
Internet | 81 words — 1% |
| 4 | Hairani Hairani, Anthony Anggrawan, M. Ade Candra. "Prediction of Electricity Usage with Back-propagation Neural Network", International Journal of Engineering and Computer Science Applications (IJECSA), 2022
Crossref | 61 words — 1% |
| 5 | repository.unika.ac.id
Internet | 59 words — 1% |
| 6 | Kiril Antevski, Luigi Girletti, Carlos J. Bernardos, Antonio de la Oliva, Jorge Baranda, Josep Mangués-Bafalluy. "A 5G-Based eHealth Monitoring and Emergency Response System: Experience and Lessons Learned", IEEE Access, 2021
Crossref | 45 words — 1% |
| 7 | journal.universitasbumigora.ac.id
Internet | 45 words — 1% |

-
- 8 Saranya A, Mukul Bhambri, Vinothkumar Ganesan. "A Cost-Effective Smart E-Bin System for Garbage Management Using Convolutional Neural Network", 2021 International Conference on System, Computation, Automation and Networking (ICSCAN), 2021
Crossref 43 words — 1%
-
- 9 latamt.ieeer9.org
Internet 42 words — 1%
-
- 10 Denilton Silveira Oliveira, Luciane Terra Dos Santos Garcia, Luiz Marcos Garcia Goncalves. "A Survey on Continuing Education of Teachers in Educational Robotics", 2021 Latin American Robotics Symposium (LARS), 2021 Brazilian Symposium on Robotics (SBR), and 2021 Workshop on Robotics in Education (WRE), 2021
Crossref 40 words — 1%
-
- 11 Marcantonio Catelani, Lorenzo Ciani, Alessandro Bartolini, Giulia Guidi, Gabriele Patrizi. "Standby Redundancy for Reliability Improvement of Wireless Sensor Network", 2019 IEEE 5th International forum on Research and Technology for Society and Industry (RTSI), 2019
Crossref 38 words — 1%
-
- 12 repositori.uji.es
Internet 38 words — 1%
-
- 13 pen.ius.edu.ba
Internet 37 words — 1%
-
- 14 David Carvajal-Arango, Sara Bahamón-Jaramillo, Paula Aristizábal-Monsalve, Alejandro Vásquez-Hernández et al. "Relationships between lean and sustainable construction: Positive impacts of lean practices over

sustainability during construction phase", Journal of Cleaner Production, 2019

Crossref

15 e-technik.org 33 words — < 1%

Internet

16 jamt.utm.edu.my 33 words — < 1%

Internet

17 www.studocu.com 31 words — < 1%

Internet

18 Mohamed Zerara. "Machine Learning and Statistical Methods for Time Series Forecasting: a Case Study with Water Demand", Institute of Electrical and Electronics Engineers (IEEE), 2021 30 words — < 1%

Crossref Posted Content

19 Saeed Mian Qaisar, Sibgatullah I. Khan, Dominique Dallet, Ryszard Tadeusiewicz, Paweł Pławiak. "Signal-piloted processing metaheuristic optimization and wavelet decomposition based elucidation of arrhythmia for mobile healthcare", Biocybernetics and Biomedical Engineering, 2022 30 words — < 1%

Crossref

20 Sinan Salim Mohammed Sheet, Mohammed Sabah Jarjees. "Microcontroller based in vitro hematocrit measurement system", Indonesian Journal of Electrical Engineering and Computer Science, 2020 30 words — < 1%

Crossref

21 M. Dotoli, N. Epicoco. "Emerging Issues in Control, Decision, and ICT Approaches for Smart Waste Management", 2019 6th International Conference on Control, Decision and Information Technologies (CoDIT), 2019 29 words — < 1%

Crossref

-
- 22 Raja Wasim Ahmad, Khaled Salah, Raja Jayaraman, Ibrar Yaqoob, Mohammed Omar. "Blockchain for Waste Management in Smart Cities: A Survey", IEEE Access, 2021
Crossref 29 words — < 1%
-
- 23 www.ncbi.nlm.nih.gov
Internet 29 words — < 1%
-
- 24 Assaf Arief, Dana Indra Sensuse. " Designing A Conceptual Model for Smart Government in Indonesia using Delphi 2 Round Validity ", 2018 International Conference on Advanced Computer Science and Information Systems (ICAC SIS), 2018
Crossref 28 words — < 1%
-
- 25 online-journals.org
Internet 28 words — < 1%
-
- 26 www.mdpi.com
Internet 27 words — < 1%
-
- 27 Dushyant Kumar Singh, Rajeev Sobti. "Long-range real-time monitoring strategy for Precision Irrigation in urban and rural farming in society 5.0", Computers & Industrial Engineering, 2022
Crossref 26 words — < 1%
-
- 28 webthesis.biblio.polito.it
Internet 26 words — < 1%
-
- 29 jurnal.harapan.ac.id
Internet 25 words — < 1%
-
- 30 Divyansh Agrawal, Sachin Minocha, Suyel Namasudra, Amir H. Gandomi. "A robust drug 23 words — < 1%

recall supply chain management system using hyperledger blockchain ecosystem", Computers in Biology and Medicine, 2022

Crossref

31	WWW.mdpi.com Internet	23 words — < 1%
32	pdfs.semanticscholar.org Internet	23 words — < 1%
33	www.fs.vsb.cz Internet	22 words — < 1%
34	Himadri Nath Saha, Sourav Gon, Annesha Nayak, Samabrita kundu, Sumandrita Moitra. "Iot Based Garbage Monitoring and Clearance Alert System", 2018 IEEE 9th Annual Information Technology, Electronics and Mobile Communication Conference (IEMCON), 2018 Crossref	21 words — < 1%
35	www.coursehero.com Internet	21 words — < 1%
36	journals.nawroz.edu.krd Internet	19 words — < 1%
37	dspace.chitkara.edu.in Internet	18 words — < 1%
38	Xiangru Chen. "Machine learning approach for a circular economy with waste recycling in smart cities", Energy Reports, 2022 Crossref	15 words — < 1%
39	patents.justia.com Internet	15 words — < 1%

- 40 repository.essex.ac.uk
Internet 14 words — < 1%
-
- 41 Anthony Anggrawan, Dwi Kurnianingsih, Christofer Satria. "Sistem Aplikasi Cerdas Klasterisasi Penerima Bantuan Covid-19", MATRIK : Jurnal Manajemen, Teknik Informatika dan Rekayasa Komputer, 2022
Crossref 13 words — < 1%
-
- 42 Raden Muhammad Anshori, Guruh Samodra, Djati Mardiatno, Junun Sartohadi. "Volunteered geographic information mobile application for participatory landslide inventory mapping", Computers & Geosciences, 2022
Crossref 13 words — < 1%
-
- 43 www.researchgate.net
Internet 13 words — < 1%
-
- 44 Elena Friedrich, Cristina Trois. "Quantification of greenhouse gas emissions from waste management processes for municipalities – A comparative review focusing on Africa", Waste Management, 2011
Crossref 12 words — < 1%
-
- 45 "International Conference on Intelligent Computing and Smart Communication 2019", Springer Science and Business Media LLC, 2020
Crossref 11 words — < 1%
-
- 46 "Table of Contents", 2012 Fourth International Conference on Computational and Information Sciences, 2012.
Crossref 11 words — < 1%
-
- 47 buetclub.buet.ac.bd
Internet 11 words — < 1%

- 48 Internet 11 words — < 1%
-
- 49 sei.ardascience.com Internet 11 words — < 1%
-
- 50 thescipub.com Internet 10 words — < 1%
-
- 51 Akhila Assis, Aleena Rose Biju, N A Alisha, Amrutha Dhanadas, Nitheesh Kurian. "Garbage Collecting Robot Using YOLOv3 Deep Learning Model", 2021 International Conference on Advances in Computing and Communications (ICACC), 2021 Crossref 9 words — < 1%
-
- 52 worldwidescience.org Internet 9 words — < 1%
-
- 53 www.amazon.co.uk Internet 9 words — < 1%
-
- 54 www.hindawi.com Internet 9 words — < 1%
-
- 55 "Intelligent Manufacturing and Mechatronics", Springer Science and Business Media LLC, 2022 Crossref 8 words — < 1%
-
- 56 Behzad Esmaeilian, Ben Wang, Kemper Lewis, Fabio Duarte, Carlo Ratti, Sara Behdad. "The future of waste management in smart and sustainable cities: A review and concept paper", Waste Management, 2018 Crossref 8 words — < 1%
-
- 57 L Megalan Leo., S Yogalakshmi., A Jerrin Simla., R.Thandaiah Prabu, P Sathish Kumar, G Sajiv.. "An 8 words — < 1%

IoT Based Automatic Waste Segregation and Monitoring System", 2022 Second International Conference on Artificial Intelligence and Smart Energy (ICAIS), 2022

Crossref

58 S. R. Jino Ramson, S. Vishnu, Alfred Kirubaraj, Theodoros Anagnostopoulos, Adnan Abu-Mahfouz. 8 words — < 1%
"A LoRaWAN IoT-Enabled Trash Bin Level Monitoring System", IEEE Transactions on Industrial Informatics, 2022

Crossref

59 docplayer.info 8 words — < 1%
Internet

60 link.springer.com 8 words — < 1%
Internet

61 www.neliti.com 8 words — < 1%
Internet

62 "IoT as a Service", Springer Science and Business Media LLC, 2018 7 words — < 1%

Crossref

63 Gerald K. Ijamaru, Li Minn Ang, Kah Phooi Seng. 7 words — < 1%
"Transformation from IoT to IoV for waste management in smart cities", Journal of Network and Computer Applications, 2022

Crossref

EXCLUDE QUOTES OFF

EXCLUDE BIBLIOGRAPHY OFF

EXCLUDE SOURCES OFF

EXCLUDE MATCHES OFF