

An Analysis on Structural Ambiguity's Patterns of The Most Watched News Headlines in BBC News

By Diah Supatmiwati

An Analysis on Structural Ambiguity's Patterns of The Most Watched News Headlines in BBC News

Alan Cahya Saputra, Diah Supatmiwati, Erwin Suhendra.

Universitas Bumigora
alans9995@gmail.com
Universitas Bumigora
diah.supatmiwati@universitasbumigora.ac.id
Universitas Bumigora
erwindebater@gmail.com

Received: | Revised: | Accepted:
Email Correspondence: diah.supatmiwati@universitasbumigora.ac.id

Abstract

News is a particular content of media talk that has pulled in extraordinary intrigued. This think about picks up knowledge into how language structure shapes the representation of data in news stories. This research is a qualitative research on pattern of ambiguous headlines entitled "An Analysis on Structural Ambiguity's Patterns Found in The Most Watched News Headlines in BBC NEWS". The aim of this research is to find the pattern of structural ambiguity of the most watched news in BBC News headlines. Collecting data inquires library data collection method (reading and note-taking technique). In this research, the researcher distinguishes the structural patterns using the syntactic theory of constituency grammar by Jurafsky (2014). The result of this research is seven of eight data which are data 1, data 2, data 4, data 5, data 6, data 7, and data 8 were ambiguous because of the order of the Preposition Phrase. In line with it, one of eight data which is data 3 was ambiguous because of the status of Verb Phrase.

Keywords: Syntax, Structural Ambiguity, Sentence Structure.

1 INTRODUCTION

Language is built from words that represent ideas, feelings, and emotions of its users, and language has function as the main medium of human to communicate with each other. Furthermore, every language represents its own interpretations of how the world works. People use language by forming a word to convey messages and information to other people directly or indirectly with both spoken and written language.

Nowadays, people are easier to collect information from any sources. For example, the headline in online news contains a lot of information that can be collected by every people. News is a specific text of media that attract people interest. There are many online news platforms providing the updated news of domestic news even the world news in their own website such as BBC News, FOX News, CNN News, Wall Street Journal.

The researcher uses the news from BBC News as the data of the research. BBC News is presented in English as a site that focuses on providing international news. BBC News provides some categories of

news. Based on those categories, the researcher selects the Most Watched News category as the source of data. The researcher is interested to observe the sentence structure in the headlines of most watched news that is published in the website of BBC News with the general purpose to observe how people can derive the ambiguity of the most watched news headlines portrayed in the BBC News based on the sentence structure.

Ambiguity is the phenomenon that an expression has more than one interpretation in its context. When people read a written form of communication, people can be misled by the word of the written text, and ambiguity could be happened as an unavoidable phenomenon in communication. According to Fromkin (1983:169), "A word or a sentence is ambiguous if it can be understood or interpreted in more than one way." According to Ullmann (1977), ambiguity is divided into three kinds such as phonetic, lexical and grammatical, but this research focuses only on the structural ambiguity.

The communication will be more efficient and effective when there is a proper structure in communication because the hearer will understand clearly what the speaker is talking about without any ambiguity. In this research, the researcher is going to analyze the ambiguity that occurred in the headlines of online news.

Based on the phenomenon and explanation above, the researcher is interested to conduct the research about ambiguities. The research question will be drawn from the view of phrases which contains ambiguities found in Most Watched News Headlines in BBC News. What are the patterns of structural ambiguity that are observed in the most watched news headlines in BBC News? Besides the research question, the objective of the research is to find the pattern of structural ambiguity of the most watched news headlines in BBC News. The significance of this research is that this research will provide new insights of how people should aware with the structure of languages.

Richard and Schmidt (2002) define linguistics as the study of language that be a system of human communication. Furthermore, linguistics has different branches such as Phonology, Syntax, Semantics, and Pragmatics. Because this research is purposed to figure out the phrase structure of the most watched news headlines in BBC news, the theory of Syntax and other theories related to Syntax are used to accomplish this research. According to Fromkin(2003), Syntax is the part of the grammar which represents a speaker's knowledge of sentences and its structures. Syntax refers to the rules and principle that determine the structure of languages. Furthermore, Syntax also refers to the rules that determine the behavior of language.

In finishing this research, the researcher used the theory of constituency grammar by Jurafsky (2014). A constituent is a linguistic part of a larger sentence, phrase, or clause that has function as single units which can be a morpheme, word, phrase, or clause, and the analysis of constituent grammar can be used to identify the structure of languages.

2 RESEARCH METHOD

This research employed qualitative descriptive approach. According to Creswell (2012), qualitative research is a means for exploring and understanding the meaning individuals or groups ascribe to a social human problem. Moreover, Qualitative research aims to give an overall picture of the problem from the perspective of the person being studied. Qualitative research refers to ideas. It is not possible to measure everything, such as the perceptions, opinions, and beliefs. Then, Descriptive method is a method examining the status of a group of humans, an object, condition, system of thought or event in the present. Descriptive research usually has two objectives, to know certain physical developments and describe in detail certain social phenomena.

The researcher used document analysis or content analysis of qualitative descriptive research. Content analysis focuses on analyzing recorded material such as public records, textbooks, letters, films, reports, and etc. Qualitative researcher does the research by focusing on total picture rather than breaking it into variables. The researcher analyzes the linguistic phenomenon called ambiguity that is found in the most watched news headline in BBC news. In conducting the research, the researcher uses syntactic theory. Moreover, the theories used to analyze the data is the constituency grammar by Jurafsky.

The first thing that the researcher do is finding the pattern of the phrases using Phrase Structure rules. The theory of constituent grammar by Jurafsky will be used to analyze the structural ambiguity which are the word order or word structure.

The data is collected from the sub-categories of several news categories found in BBC News entitled "Most Watched News" in BBC News official website <https://www.bbc.com>. The data that are used in this study are 8 data selected from 40 data after the data are reduced. The data are accessed in November 2021 until December 2021.

Technique of collecting data used in this research is document analysis technique. This technique is divided into two process such as content analysis and thematic analysis. Content analysis is the process of organizing information into categories related to the research question. Content analysis contains three procedures such as determining the analysis unit, determining the sample, and note-taking. Meanwhile, thematic analysis is a form of noting patterns in data with emerging themes becoming analysis categories. This process involves reading and reviewing the data more carefully and with focus.

Technique of data analysis used in this research is taken from Miles and Huberman's book entitled "Qualitative Data Analysis edition 3" (2014). According to this book, data analysis consists of three activities occurring simultaneously such as data condensation, data display, conclusion drawing/verification. Moreover, data condensation refers to the process of selecting, centralizing, simplifying, abstracting, and transforming data appearing in field notes or transcripts using document.

Then, data display is a compressed and organized collection of information from which conclusions and actions can be drawn. The conclusion is verified as the analyst proceeds.

3 FINDINGS AND DISCUSSION

In this chapter, the researcher analyzes and discusses the collected data. Besides, this chapter answers the problem based on the theories that are mentioned above, and the researcher discusses the analysis of the structural ambiguity found in the Most Watched News headlines in BBC News World.

3.1 FINDINGS

After the data were analyzed using the technique of analyzing data, the researcher found that there are 8 of 40 data containing structural ambiguity in it. As the research questions suggested, there are 7 data that are ambiguous which are data 1, data 2, data 4, data 5, data 6, data 7, and data 8 because of the position of the PP, and 1 data is ambiguous which is data 3 because of the order of VP.

Table 1. Ambiguous Headlines

No.	Headlines of News in BBC News	Date of the News
1	Cheeky parrot plays peekaboo with traffic camera	3 rd of November, 2021
2	'Flippers united people in the joy of skating'	5 th of November, 2021
3	The space telescopes inspired by lobsters	8 th of November, 2021
4	Astronauts return to Earth on SpaceX capsule	10 th of November, 2021
5	Heat camera shows migrants on Poland-Belarus border	13 th of November, 2021
6	Water cannons fired at Covid protesters in Belgium	22 nd of November, 2021
7	Super typhoon leaves island without power or water	21 st of December 2021
8	Fires tear through hundreds of homes in Colorado	31 st of December, 2021

3.2 DISCUSSION

There are 8 data that contain structural ambiguity. The ambiguous headlines are analyzed using the constituency grammar. The further explanation is discussed below.

3.2.1 Data 1: Cheeky parrot plays peekaboo with traffic camera.

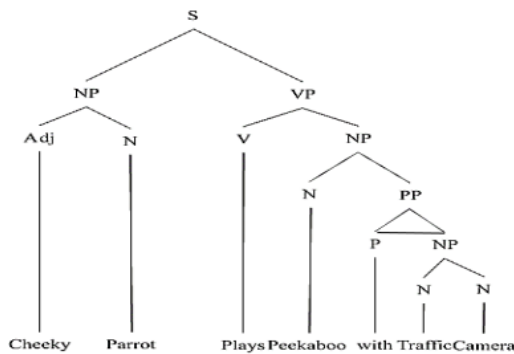

Figure 1a Data 1

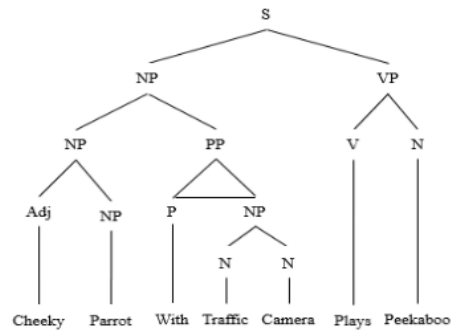

Figure 1b Data 1

Structurally, the headline above has two different meanings and interpretations. The first meaning is “the cheeky parrot plays peekaboo with the traffic camera”, and the second meaning is “the cheeky parrot with traffic camera plays peekaboo”. In *figure 1a*, the PP belongs to the N of “Peekaboo” while in *figure 1b*, the PP belongs to the NP of “Cheeky parrot”. The interpretations that can be drawn based on those two figures are the *figure 1a* interprets the first meaning because the PP plays role as the complement of peekaboo, and the *figure 1b* interprets the second meaning because the PP plays role as the complement of the NP of “Cheeky parrot”.

3.2.2 Data 2: 'Flippers united people in the joy of skating'

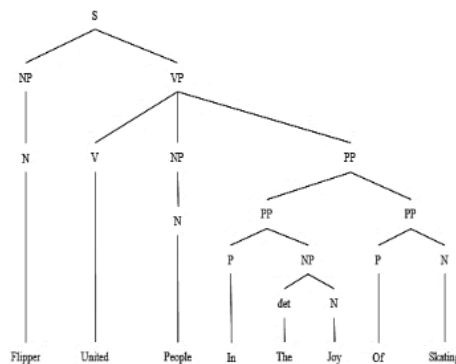

Figure 2a data 2



Figure 2b data 2

The headline above has two different meanings and interpretations which are the first meaning is “the flippers united people in the joy of skating”, and the second meaning is “the flippers of skating united people in the joy”. In *figure 2a*, the PP belongs to the NP of “People”, but the PP of “Of skating” belongs to the NP of “Flippers” in *figure 2b*. The *figure 2a* interprets the first meaning

because the PP plays role as the complement of “People”. However, the *figure 2b* interprets the second meaning because the PP plays role as the complement of the NP in subject position.

3.2.3 Data 3: The space telescopes inspired by lobsters

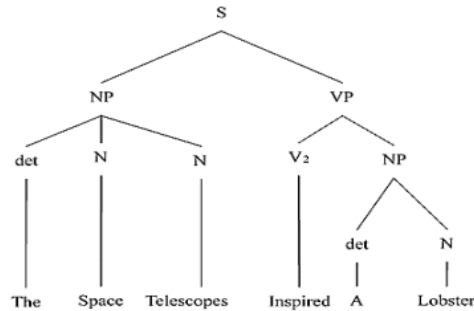

Figure 3a data 3

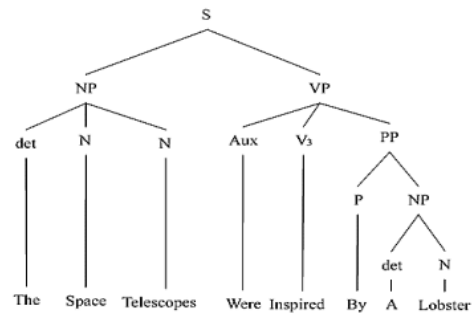

Figure 3b data 3

Based on structure, the headline above has

two different meanings and interpretations. The first meaning is “the space telescopes inspired a lobster”, and the second meaning is “the space telescopes were inspired by a lobster”. The dissimilarity of the structures of phrases above is shown in the VP of the phrases. In the *figure 3a*, the VP is shown the past form of inspire which is “inspired” in active voice structure while the *figure 3b* shows the passive voice form of the phrase. Based on the structure in *figure 3a*, the subject is “The space telescopes”, and the object is “a lobster”. However, *figure 3b* has “a lobster” as the subject and “The space telescopes” as the object. This can happen because of the passive voice form where the position of subject is switched with the position of the object, and the VP is using Auxiliary verb followed by V₃. Moreover, subject in the passive voice must be followed by “by” before it because the word “by” is indicating passive voice.

3.2.3 Data 4: Astronauts return to Earth on

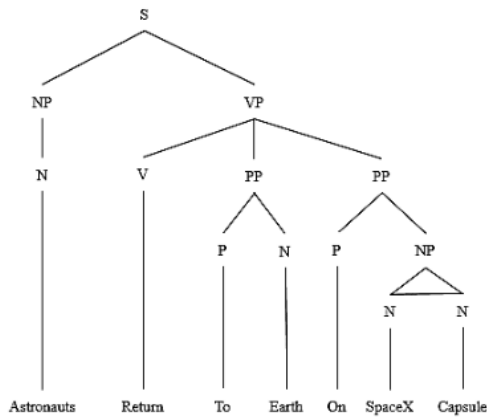

Figure 4a data 4

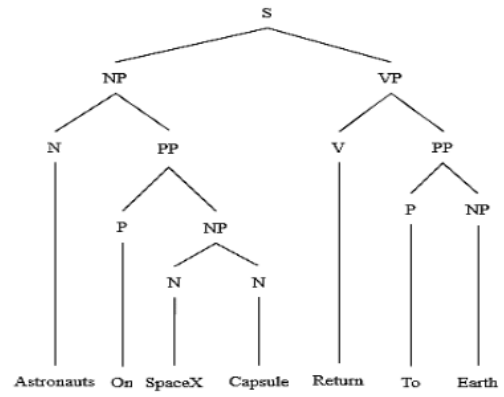

Figure 4b data 4

SpaceX capsule

Based on structure, the headline above has two different meanings and interpretations. The first meaning is “Astronauts return to Earth using the SpaceX capsule”, and the second meaning is “Astronauts who are using SpaceX capsule return to Earth”. In *figure 4a*, the PP of “on SpaceX capsule” belongs to the PP of “to earth” while in *figure 4b*, the PP of “on SpaceX capsule” belongs to the NP of “Astronauts”. The *figure 4a* interprets the first meaning because the PP plays role as the adjunct of the VP, and the *figure 4b* interprets the second meaning because the PP of “on SpaceX capsule” plays role as the complement of the NP of “Astronauts”.

3.2.4 Data 5: Heat camera shows migrants on

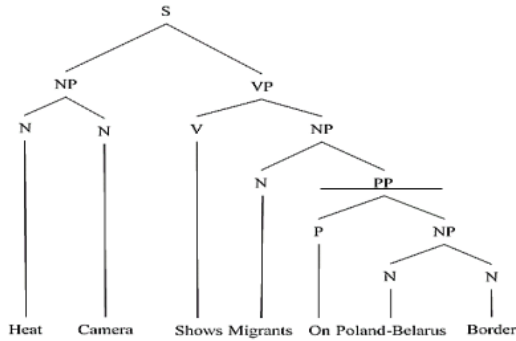

Figure 5a data 5

Poland-Belarus border

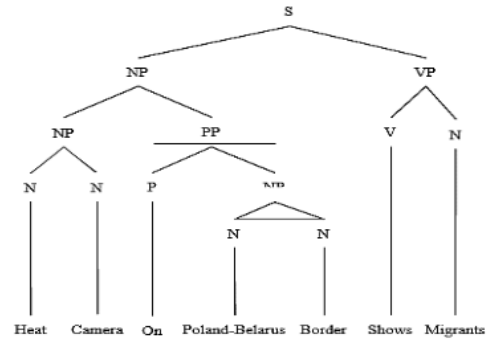

Figure 5b data 5

The headline above has two different meanings and interpretations. The first meaning is “Heat camera shows migrants who live in Poland-Belarus border”, and the second meaning is “Heat camera on Poland-Belarus border shows migrants”. In *figure 5a*, the PP of “on Poland-Belarus border” belongs to the NP of “Migrants” however in *figure 5b*, the PP of “on Poland-Belarus border” belongs to the NP of “Heat camera”. The *figure 5a* interprets the first meaning because the PP plays role as the complement of the NP of “Migrants”. However, the *figure 5b* interprets the second meaning because the PP plays role as the complement of the NP of “Heat camera”.

3.2.5 Data 6: Water cannons fired at Covid protesters in Belgium

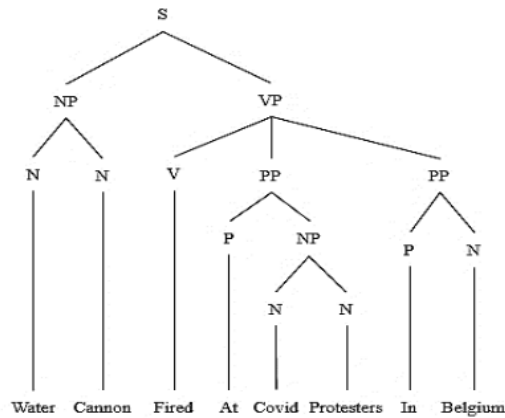

Figure 6a data 6

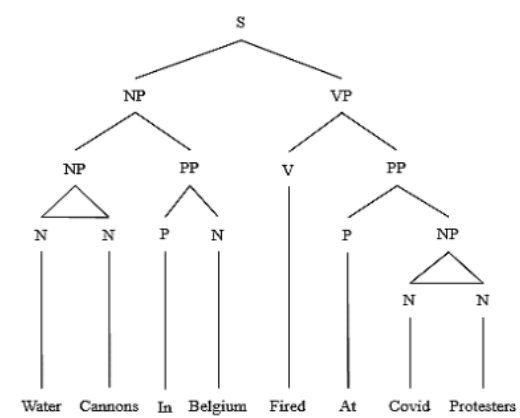

Figure 6b data 6

Based on structure, the headline above has two different meanings and interpretations. The first meaning is “Water cannons fired at Covid protesters who are in Belgium” meanwhile the second meaning is “Water cannons in Belgium fired at Covid protesters”. In *figure 6a*, the PP of “in Belgium” is the adjunct of VP while in *figure 6b*, the PP of “in Belgium” belongs to the NP of “Water cannon”. The *figure 6a* interprets the first meaning which “Water cannons fired at Covid protesters who are in Belgium” because the PP plays role as the adjunct of the NP “Covid protester”. However, the *figure 6b* interprets the second meaning because the PP of “in Belgium” plays role as the complement of the NP of “Water cannons”.

3.2.6 Data 7: Super typhoon leaves island without power or water

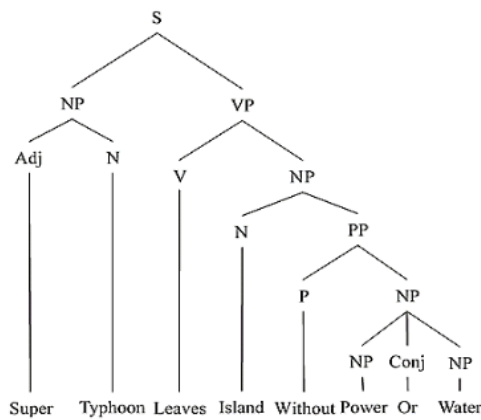

Figure 7a data 7

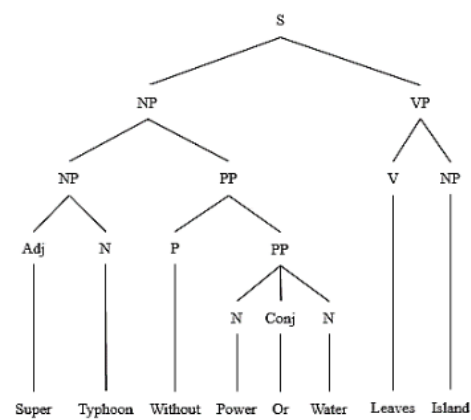

Figure 7b data 7

The headline above has two different meanings and interpretations. The first meaning is “Super typhoon leaves island that has no power or water”, and the second meaning is “Super typhoon without power or water leaves island”. In *figure 7a*, the PP of “without power or water” belongs to the NP of “Island” while in *figure 7b*, the PP of “without power or water” belongs to the NP of “Super typhoon”. The *figure 7a* interprets the first meaning because the PP plays role as the complement of the NP of “Island”, and the *figure 7b* interprets the second meaning because the PP of “without power or water” plays role as the complement of the NP of “Super typhoon”.

3.2.8 Data 8: Fires tear through hundreds of homes in Colorado

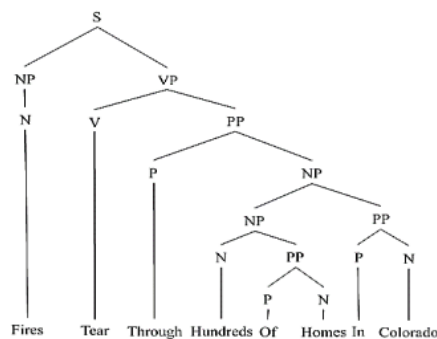

Figure 8a data 8

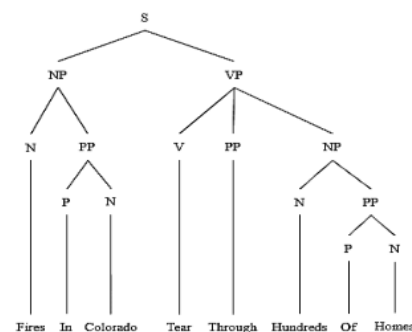

Figure 8b data 8

Structurally, the headline above has two different meanings and interpretations. The first meaning is “Fires tear hundreds of homes in Colorado”, and the second meaning is “Fires in Colorado tear hundreds of homes”. In *figure 8a*, the PP of “In Colorado” belongs to the NP of “Hundreds of homes” while in *figure 8b*, the PP of “In Colorado” belongs to the NP of “Fires”. The *figure 8a* interprets the first meaning because the PP of “In Colorado” plays role as the adjunct of the NP of “Hundreds of homes”. However, the *figure 8b* interprets the second meaning because the PP of “In Colorado” plays role as the complement of the NP of “Fires”.

4 CONCLUSION

The results of the finding and discussion of this research show that the syntactic structure can be ambiguous. The most frequent ambiguous structure that were found in this research is in the Prepositional Phrase. Seven of eight data which are data 1, data 2, data 4, data 5, data 6, data 7, and data 8 were ambiguous because of the order of the Preposition Phrase. In line with it, one of eight data which is data 3 was ambiguous because of the status of Verb Phrase.

The order of Preposition Phrase makes the phrase ambiguous because it can refer to the Agent of the phrase or to the Theme of the phrase. However, the ambiguous phrase that occur because of the Verb Phrase has different interpretation than the ambiguous phrase that occur because of the Prepositional Phrase.

The Agent of the phrase is obviously seen if the ambiguous phrase happened because of the Prepositional phrase. However, the Agent of phrase is ambiguous when the ambiguity occurs in the Verb Phrase. Based on the analysis of data 3, the Verb Phrase can be considered as the active voice with past form, and it also can be considered as the passive voice. When it is considered as the active voice with past form, the Agent is occurred in the NP of subject position, but the Agent is switched when it is considered as the passive voice.

5 REFERENCES

- Ahmad Dahlan, U. (2015). A Descriptive Review on Applied Linguistics and Educational Linguistics. Ahmad Dahlan Journal of English Studies (ADJES), 2(2), 32–37.
- Bowen, G. A. (2009). Document analysis as a qualitative research method. *Qualitative Research Journal*, 9(2), 27–40.
- Christopher D.Manning. (2021). Speech and Language Processing: An introduction to natural language processing. *Speech and Language Processing An Introduction to Natural Language Processing Computational Linguistics and Speech Recognition*, 1–18. <http://www.cs.colorado.edu/~martin/slp.html>
- Diana. (2017). The Syntactic of English Sentence Structure in Brad Bird’ The Incredibles A Thesis Submitted to English Language and Teaching Department.

Elmawati, D. (2013). Structural Ambiguity in the Headlines Compiled by Department of Languages, Cultures and Linguistics Bucknell University: A Study on the X-bar Theory. Lantern: Journal On English Language, Culture And Literature.

Fromkin, Victoria et.al. 2003. An Introduction to Language: Seventh Edition. United States: Thomson Wadsworth.

Fromkin, Victoria., Rodman, Robert., Ityani, Nina. 2006. An Introduction to language. Nelson.

Hadi, M. ZakiPahrul. (2018). A Syntactic Analysis of Reduced Clauses in The Jakarta Post's Headlines. Humanitatis: Journal on Language and Literature 5(1), 85-99.
<https://doi.org/10.30812/humanitatis.v5i1.453>

Jurafsky, D., & H. Martin, J. (2019). Constituency Grammars. Speech and Language Processing (3rd Ed. Draft), 1–31.

Miles, Matthew B., A Michael Huberman. (2014). Qualitative Data Analysis: a methods source book edition 3. SAGE Publications, Inc.

Puspitasari, J., SutjiatiBeratha, N. L., &Wandia, I. K. (2019). Lexical and Structural Ambiguity Found in Articles in The Jakarta Post Daily Newspaper. Humanis, 23, 19.
<https://doi.org/10.24843/jh.2019.v23.i01.p04>

Richards, J. C & Schmidt, R. (Eds.). (2002). Longman Dictionary of language Teaching and Applied Linguistics. (3rded.) Ney York: Longman.

Ullmann, Stephen. 1977. Semantics: An Introduction to thr Science of Meaning. Oxford: Basil Blachwell.

An Analysis on Structural Ambiguity's Patterns of The Most Watched News Headlines in BBC News

ORIGINALITY REPORT

17%

SIMILARITY INDEX

MATCH ALL SOURCES (ONLY SELECTED SOURCE PRINTED)

★digilib.uinsby.ac.id

Internet

2%

EXCLUDE QUOTES OFF

EXCLUDE SOURCES OFF

EXCLUDE BIBLIOGRAPHY OFF

EXCLUDE MATCHES OFF